

Specification

LED Neon Flex | NF-0612-Side Bending

► Product Pictures

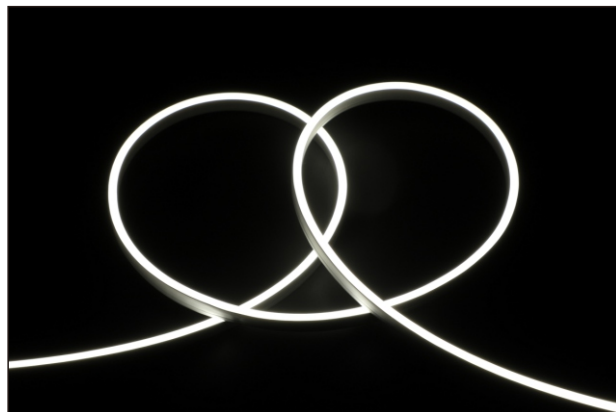

► Features

- ◆ Side-Bending LED Neon Flex (6x12mm)
- ◆ Reinforced 2835 LEDs insides
- ◆ Linear lighting performance
- ◆ Dimmable with PWM signal
- ◆ Only one Bin, SDCM<3, or SDCM<5 available
- ◆ IP-67 waterproof for indoor and outdoor
- ◆ Dow Corning silicon glue raw material

CCT / COLOR Solution

2700 K 3000 K 4000 K 6500 K R G B RGB

CE RoHS LM 80 5 Year Warranty Waterproof IP-67

► Dimension / Diagram

ITEM: NF-0612S-10W-24V-IP67-**

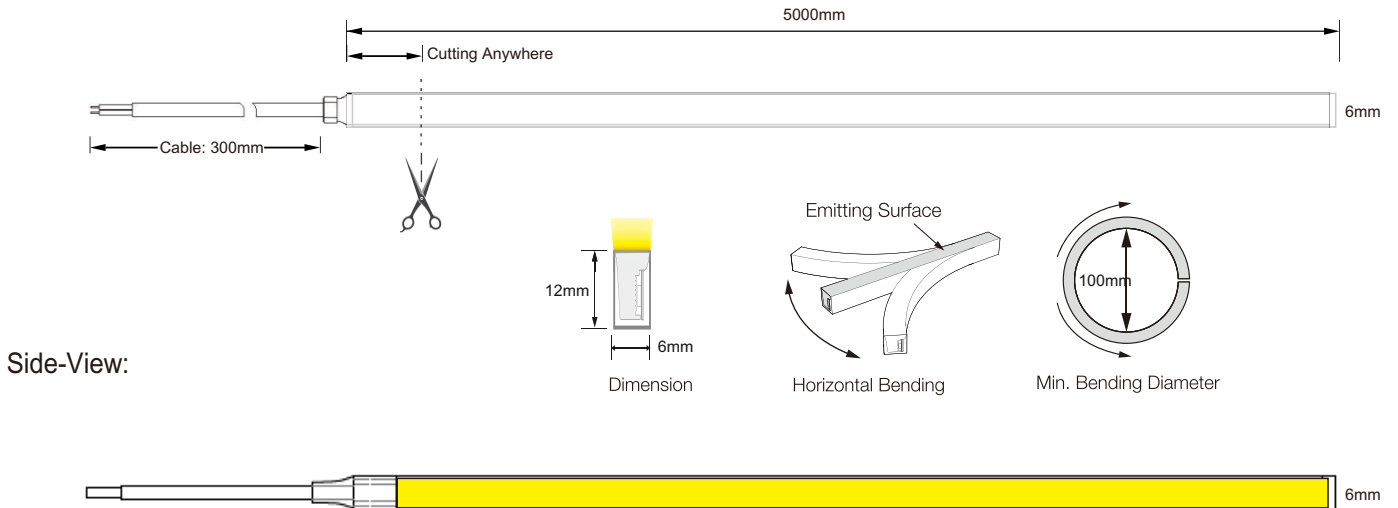

► Optical

LED type:	2835 SMD LEDs
Color rendering index:	Ra>90+
CCT Range:	2000K / 2700K / 3000K 4000K / 4500K / 6000K
Irritation angle:	120°
Light Efficiency:	30 Lm/w
Lumen output/meter:	300Lm/m
Working hour:	50,000hrs lifetime for Tc<70°C

► Electric

Input current/m:	0.42A/m
Input Voltage:	DC 24V
Voltage Power/m:	10W/m
Static Electricity:	1000V(ESD)
LEDs/meter:	120-LEDs/m
Cutting Length:	Free-cutting
Bending:	Side-bending
Working temperature:	-20°C ~ +45°C

► Light Distribution Diagram (IES)

Illuminance Distribution

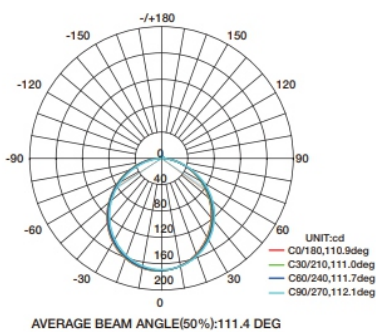

Illuminance-Distance Curve

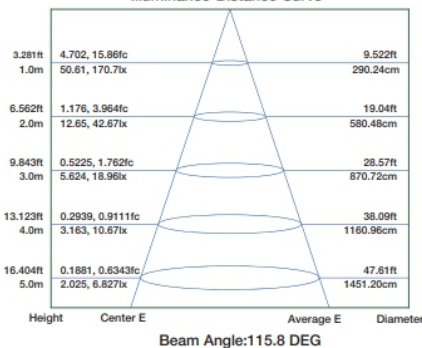

White Color Charts

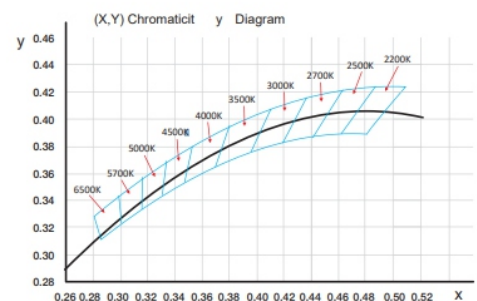

► Installation

Cutting

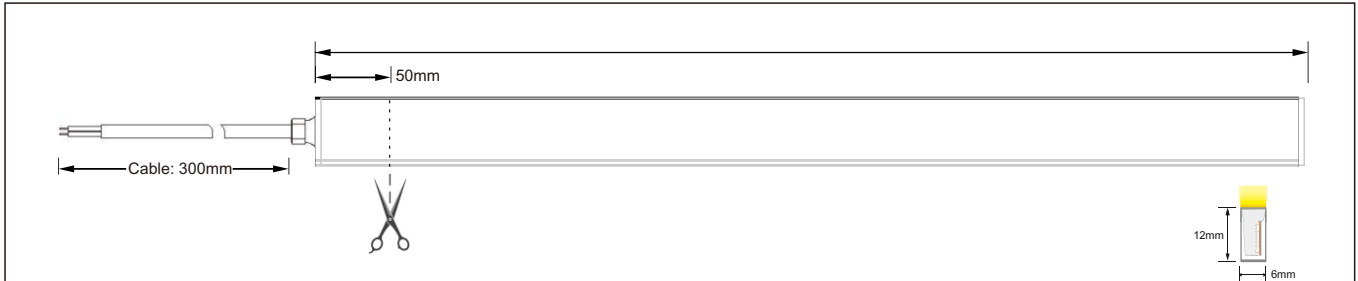

Fixed by bracket

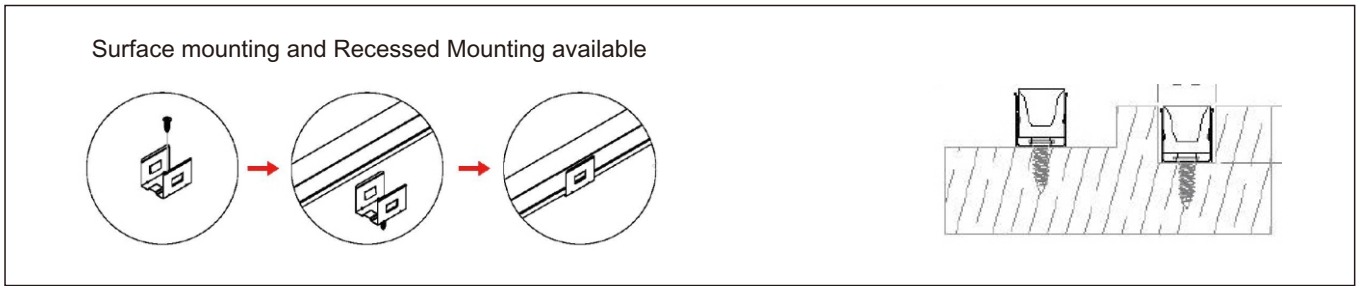

Fixed by Flexible brackets

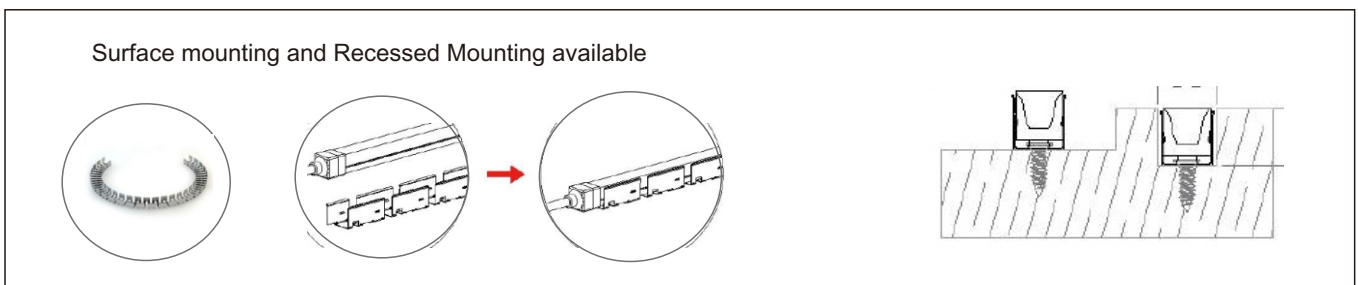

Fixed by Aluminum profile

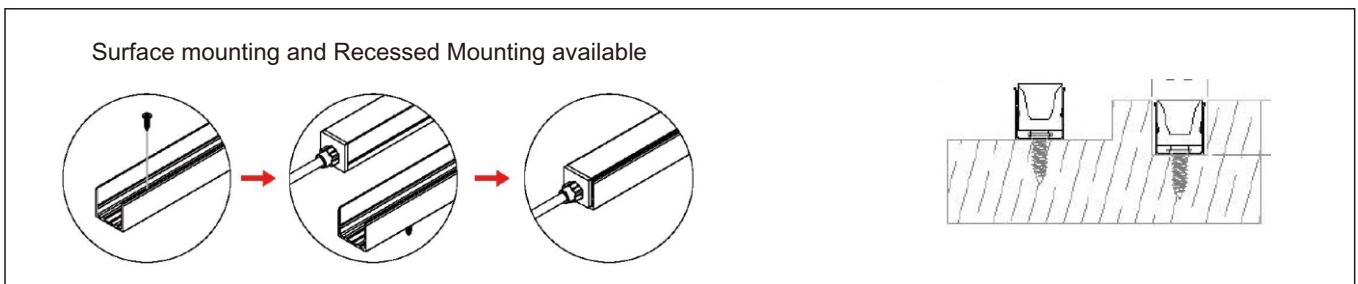

► Accessories



Bracket

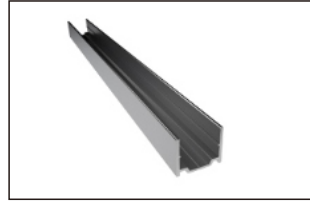

Aluminum Profile



Flexible Bracket

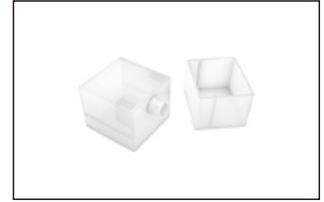

End Cap

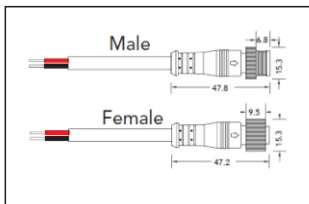

Cable

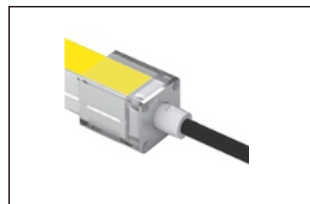

Connector



Waterproof Connector



Cable Box

► Standard Packing

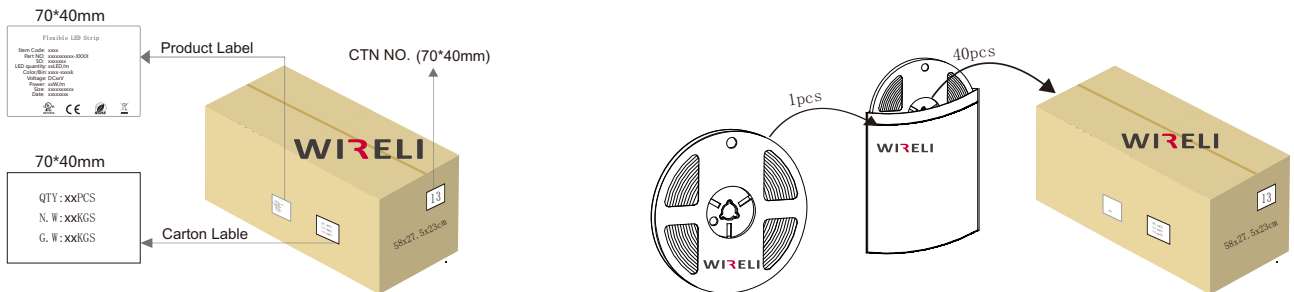

5m/10m/25m packing optional

100m/carton / 12.00KG/carton

49*35*30cm

► Order Code

Part No.	CCT	Power	Voltage	LEDs/m	CRI	Dimension	Efficiency	LM/meter	ErP Class
3202321601	3000K	10W/m	DC-24V	120-LEDs/m	>90	6x12mm	25 LM/watt	250LM/m	G
3202320601	4000K	10W/m	DC-24V	120-LEDs/m	>90	6x12mm	30 LM/watt	300LM/m	G
3202319601	6000K	10W/m	DC-24V	120-LEDs/m	>90	6x12mm	35 LM/watt	350LM/m	G