

Specification

LED Neon Flex | NF-0306-Side Bending

► Product Pictures

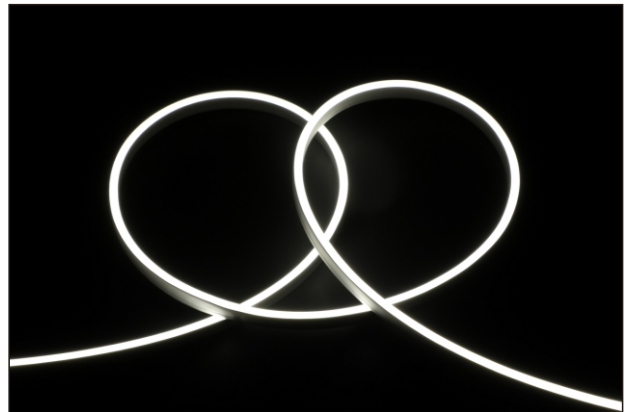

► Features

- ◆ Side-Bending LED Neon Flex (3x6mm)
- ◆ Free-Cutting and Fast-Assembling solution
- ◆ Linear lighting performance
- ◆ Dimmable with PWM signal
- ◆ Only one Bin, SDCM<3, or SDCM<5 available
- ◆ IP-54 waterproof for indoor and outdoor
- ◆ 3mm Super-slim design + Free-cutting

CCT / COLOR Solution

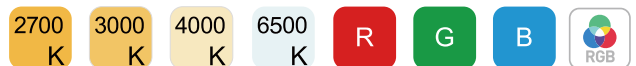

► Dimension / Diagram

ITEM: NF-0306S-9W-24V-IP54-Free cutting

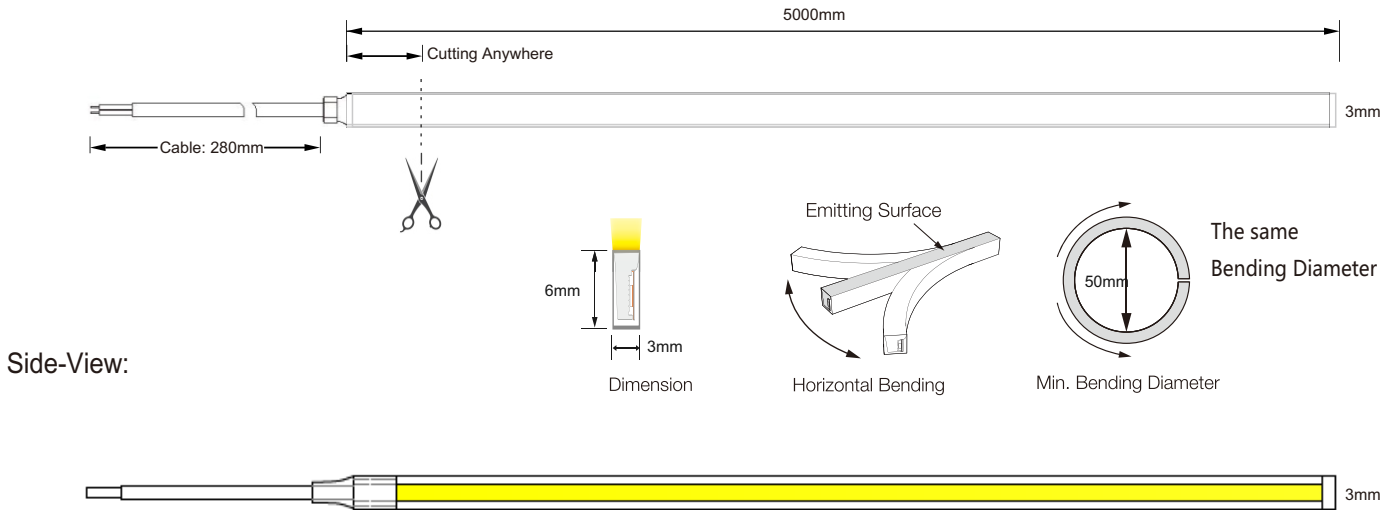

► Optical

LED type:	2835 SMD LEDs
Color rendering index:	Ra>90+
CCT Range:	2000K / 2700K / 3000K 4000K / 4500K / 6000K
Irritation angle:	120°
Light Efficiency:	30 Lm/w
Lumen output/meter:	260Lm/m
Working hour:	50,000hrs lifetime for Tc<70°C

► Electric

Input current/m:	0.42A/m
Input Voltage:	DC 24V
Voltage Power/m:	9.0W/m
Static Electricity:	1000V(ESD)
LEDs/meter:	240-LEDs/m
Cutting Length:	Free-Cutting
Bending:	Side-bending
Working temperature:	-20°C ~ +45°C

► Light Distribution Diagram (IES)

Illuminance Distribution

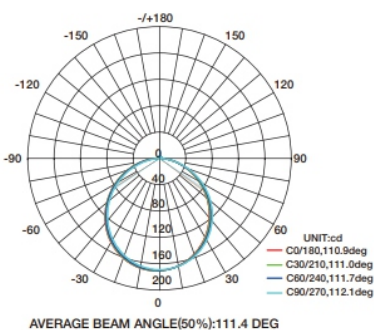

Illuminance-Distance Curve

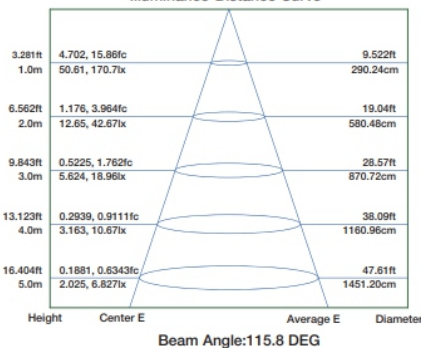

White Color Charts

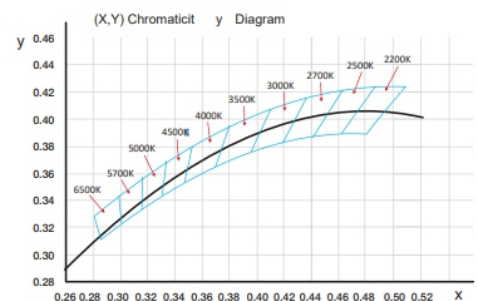

► Installation

Cutting



Fixed by Side-bending direction

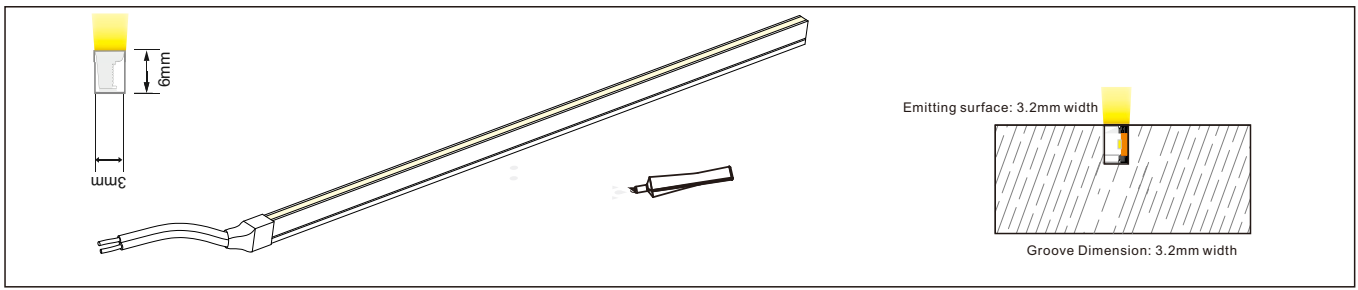

► Standard Packing

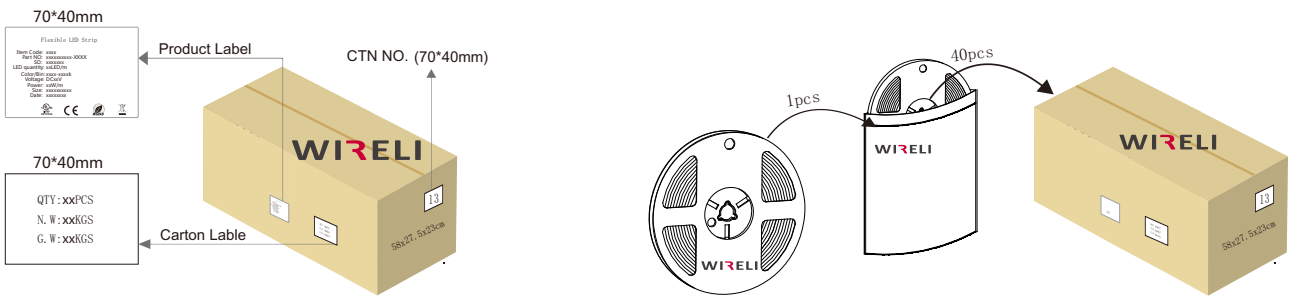

5m/10m/25m packing optional

100m/carton / 12.00KG/carton

49*35*30cm

► Order Code

Part No.	CCT	Power	Voltage	LEDs/m	CRI	Dimension	Efficiency	LM/meter	ErP Class
3202333601	3000K	9W/m	DC-24V	240-LEDs/m	>90	3x6mm	25 LM/watt	225LM/m	G
3202332601	4000K	9W/m	DC-24V	240-LEDs/m	>90	3x6mm	30 LM/watt	260LM/m	G
3202333601	6000K	9W/m	DC-24V	240-LEDs/m	>90	3x6mm	32 LM/watt	285LM/m	G